

ACC2

BUILT TO COMMAND
EVEN THE LARGEST PROJECTS

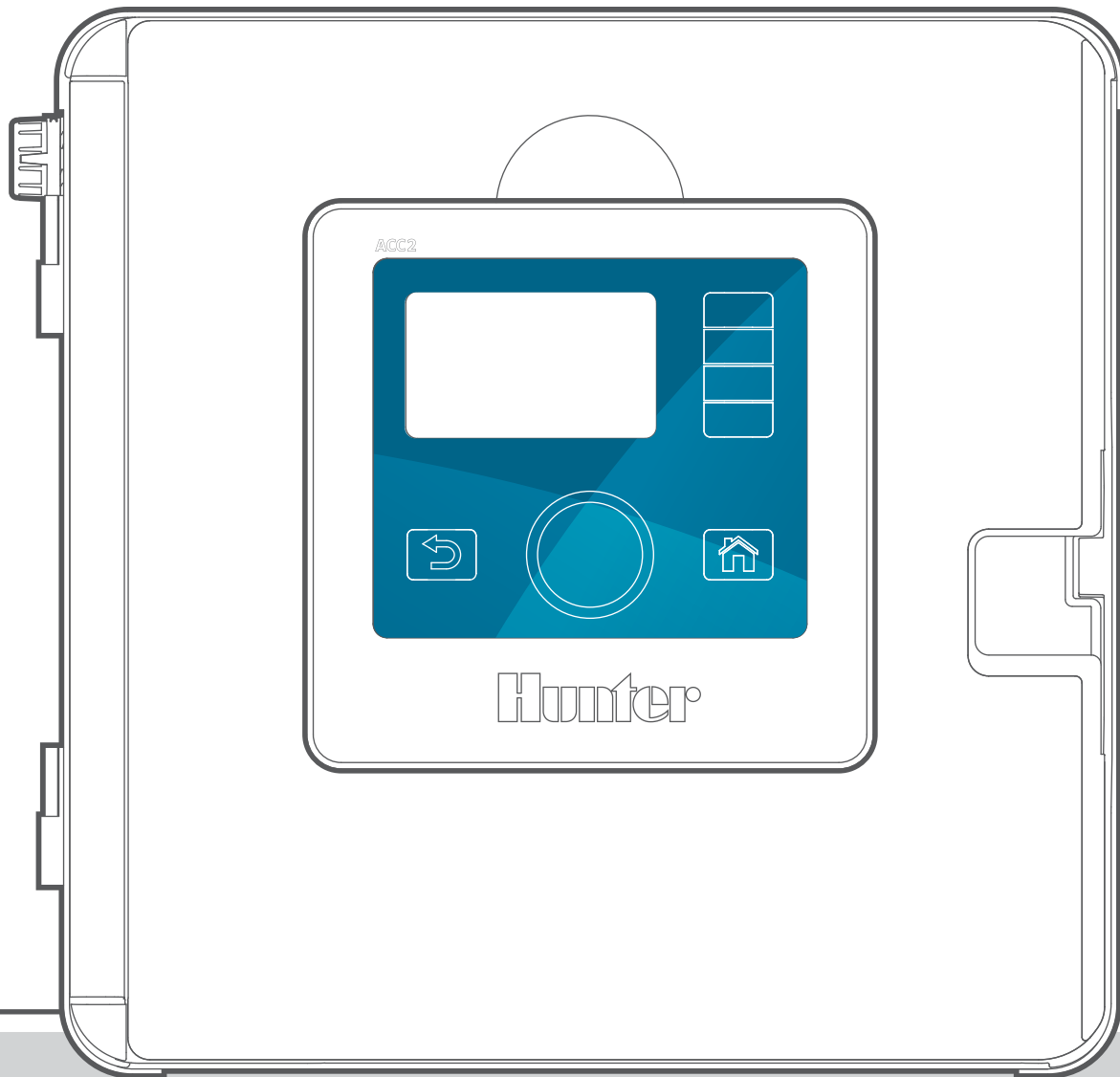

Quick Start Guide

Hunter®

POWERFUL. INTELLIGENT. FLEXIBLE.

THE ACC2 CONTROLLER DELIVERS ADVANCED WATER MANAGEMENT TO MEET THE DEMANDS OF LARGE-SCALE COMMERCIAL PROJECTS.

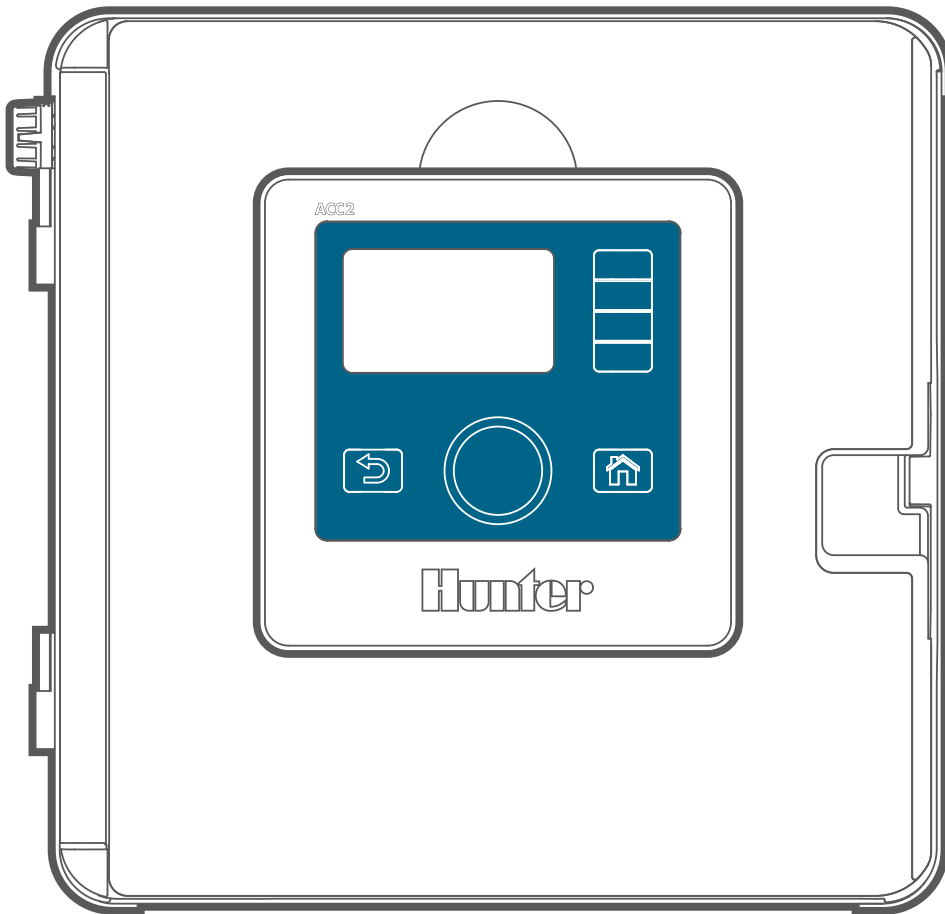

Troubleshooting

Need more helpful information on your product? Find tips on installation, controller programming and more.



 hunter.direct/acc2

 1-800-733-2823

TABLE OF CONTENTS

Important Connections and Tips	4	Sensors	18	Set Up Flow Monitor	33
Facepack	4	Clik Sensors	18	Flow Zones	33
Reversing the Facepack	4	Sensor Response	19	Flow Map	33
Connecting and Disconnecting the Facepack	5	Solar Sync	20	Flow Limits	34
SyncPort™ Connection	5	Flow Sensors	20	Flow Allowances	34
SD Card Reader	5	Stations Menu	21	Station Setup	35
Battery	5	Station Setup	21	Station P/MV Usage	35
Internal Features	6	Cycle & Soak	22	Flow Zone	35
Facepack Cable	6	Blocks	22	Flow Priority	35
Power Supply Board Replacement	6	Station Limits	23	Flow Measurement Settings	35
Earth Ground Lug	6	Station Summary	23	Copy and Paste	35
Slide Locks	6	Devices Menu	24	Learn Flow	36
Flow Expansion	7	P/MV Operation	24	Schedule Flow Learning	36
Wire Tie Holders	7	Flow Sensors	24	Hydraulic Summary	37
Transformer Fuse	7	Solar Sync	24	Flow Totals	37
Optional Wi-Fi or LAN	7	Clik Sensors	24	View Flow	38
Operating the Controls	8	Sensor Response	24	Flow Alarm Handling	38
Attention Messages	8	Flow Menu	25	Station Level Alarms	39
Start Up Screen	8	Clear Flow Alarms	25	Flow Zone or MainSafe™ Alarms	39
View Messages	9	Settings Menu	25	Set Up Flow Manager	40
Clear Messages	9	Time/Date	25	Flow Zones	40
View Logs	9	Regional Settings	25	Flow Target	40
Home and Activity Screens	9	User Management	26	Station Setup	41
Activity Screen	10	Networking	26	Flow Zone	41
Basic Programming and Setup	11	Diagnostics Menu	27	Flow Priority	41
Names	11	View Logs	27	Flow Rate	41
Settings, Time and Date	11	Alarm Logs	27	Station Limits	42
Pump/Master Valve Setup	12	Controller logs	27	MainSafe™	42
Soft P/MVs (4-6)	12	Station Logs	28	Setup Screen	43
Manual Starts and Test	13	Filter Logs	28	Flow Limits screen	43
Stop Commands	13	Export Logs	28	Maximum Flow	43
Programs	14	Module Info	28	Unscheduled Flow	43
Start Times	14	Clik Sensor Diagnostics	28	Alarm Delay	43
Intelligent Current Sensing	15	Station-P/MV Diagnostics	29	Alarm Clear Delay	43
Run Times	15	Flow Sensor Diagnostics	29	Alarm Clear Delay	44
Water Days	16	Solar Sync Diagnostics	29	Allowances screen	44
Seasonal Adjust	16	Advanced Features	30	Monthly Budget	44
Program Rules	17	Export Logs	30	Manual Watering Allowance	44
Ignore Calendar Days Off	17	Easy Retrieve	30	Conditional Response	45
No Water Window (Start and End)	17	Reset Memory	31	SOS (Status Output Station)	45
Station Delay (Delay Between Stations)	17	Firmware Update	31	Setup an SOS station	45
Calendar Days Off	17	Conditional Response	31	Set up a Conditional Response	46
Program Summary	17	Flow Operations	32	Set up a Conditional Response	47
P/MV Operation (Pump/Master Valve Operation)	18	Flow Manager	32	Start Stations, Programs, and Blocks	48
		Flow Monitor	32	Mode	48
		MainSafe™	32	Switch P/MVs	48
				Troubleshooting	49

Important Connections and Tips

FACEPACK

“Facepack” is a Hunter term for the enclosed, removable control panel and display assembly. It contains the brain and memory of the controller.

REVERSING THE FACEPACK

The ACC2 facepack and controls can be reversed in the door frame, so they can be operated with the door open while looking at the modules and wiring.

1. Pull the facepack away from the face frame.
2. The facepack is held in place by a magnet.
3. Pass the facepack through face frame.
4. Slide the facepack into the backside of the face frame as shown.
5. Tilt the facepack into position, it will click into place and be held securely by the magnet. Tuck the ribbon cable slack into the provided pocket.

When the facepack detects that it is reversed, it will automatically go to the Diagnostics, Module Info display. It is possible to navigate to any other screen from this display, including programming and manual operations.



The controller will water automatically with the facepack in either position.

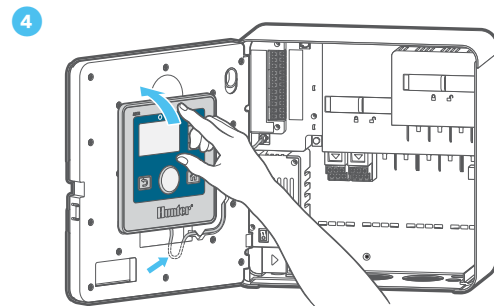
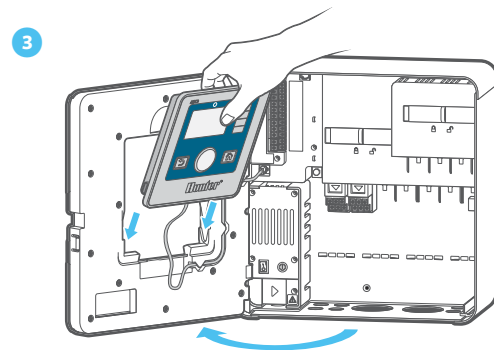
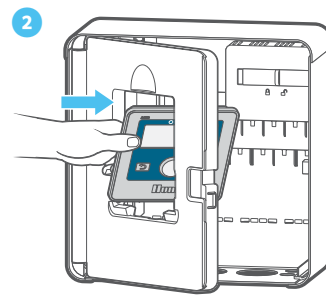
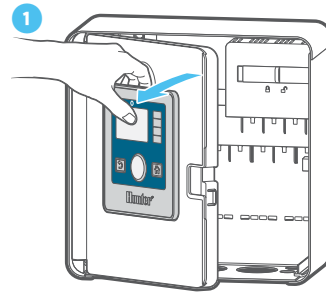

CONNECTING AND DISCONNECTING THE FACEPACK

The facepack cable connection is located just below the light on the Power Supply Board. Turn power to controller off before connecting or disconnecting the facepack.

SYNCPORT™ CONNECTION

The SyncPort connection is a proprietary Hunter connection for external interface devices. It is located near the top of the Power Supply Module.

- 1 SyncPort
- 2 Facepack Cable Connection

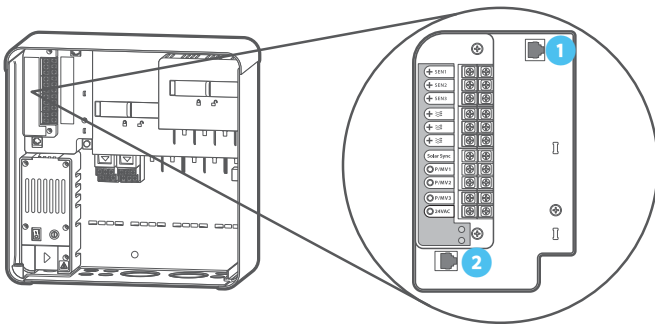

! Do not attempt to connect the facepack cable to this port. The connector has a protective cover which should be left in place until the connection is needed.

Consult the connecting device’s manual for additional instructions regarding SyncPort.

SD CARD READER

The bottom edge of the facepack includes a built-in SD card reader. The controller is supplied with an SD card.

The SD card can:

- Upload updated firmware, saved from email or the HunterIndustries.com web site, to the controller and all its modules.
- Store logs, Easy Retrieve backups, and other information for use later or on another device. *See Advanced Features menu on page 30.*

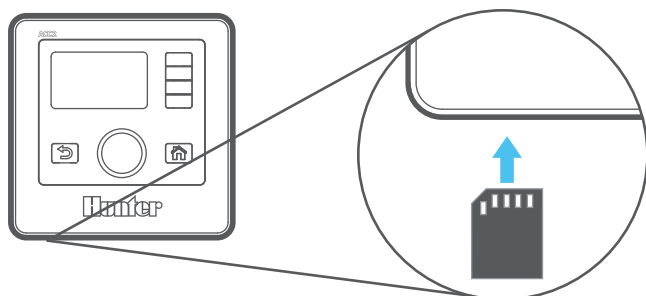

BATTERY

The ACC2 has a replaceable internal lithium battery in the side of the facepack, used to backup time settings (only during power outages). The battery may last the life of the controller, but is easily replaced if necessary.

Use a standard CR2032 replacement if necessary. Take care to place the + side of the battery correctly.

! If power to the controller is left off for extended periods, the battery will be consumed more quickly.

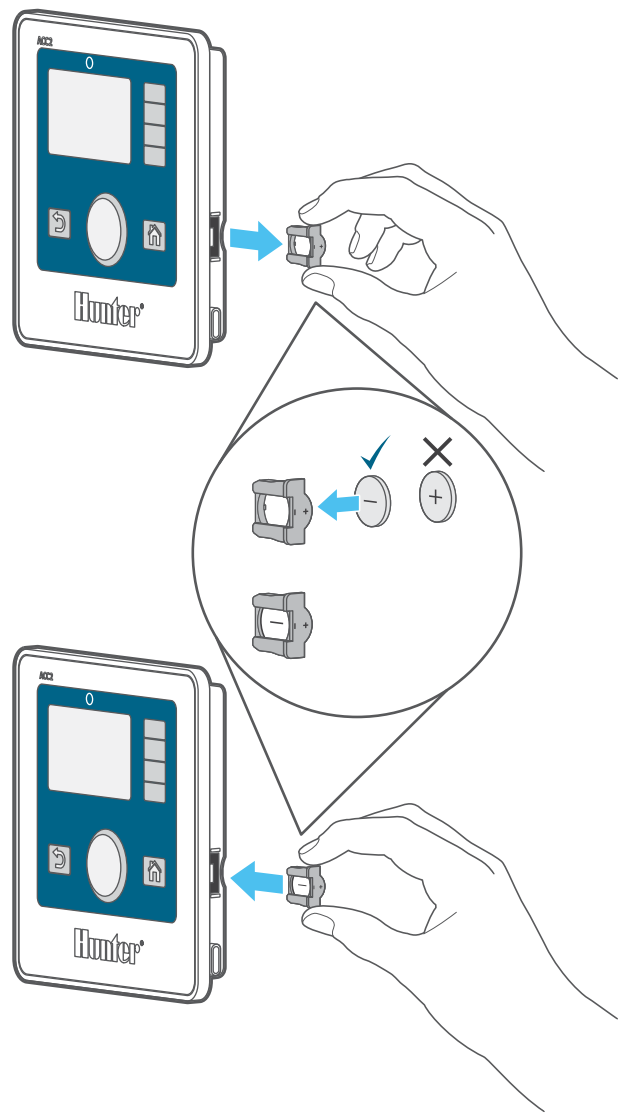

INTERNAL FEATURES

1	Facepack Cable
2	Power Supply Board
3	Earth Ground Lug
4	Slide Locks
5	Flow Expansion Module slot
6	Wire Tie Holders
7	Transformer Fuse
8	Optional Wi-Fi or LAN slot

FACEPACK CABLE

The facepack cable connection is located beneath the status light. It is a standard connector with a locking lever on one side, which must be pressed in to remove the cable.

POWER SUPPLY BOARD REPLACEMENT

The Power Supply Board, in the upper left corner of the cabinet, is a vital component, and includes connections for external sensors, Pump/Master Valve outputs, Common wire connections, and more.

The Power Supply Board is also designed for convenient replacement, if necessary. Three captive screws (#2 Phillips) secure the board. Three modular wiring plugs connect the board to the controller.

EARTH GROUND LUG

A heavy duty earth ground lug is provided for lightning and surge protection. This connection is for equipment safety only. It should always be connected with heavy copper wire to approved grounding hardware buried in the earth at least 8' (2.5 m) away from the controller.

Generally, earth ground hardware consists of a 8' (2.5 m) copper-clad steel rod driven all the way into earth, or a 8' x 4' (2.5 m x 1.25 m) wide copper plate, or both, or comparable earth grounding hardware as approved by local code.

Do not connect the primary AC power earth ground wire to this lug. ACC2 provides safety ground connection inside the transformer wiring compartment.

SLIDE LOCKS

The upper and lower slide locks secure the output modules in place. When they are open, power is off to the facepack, and an orange indicator is shown. The controller will not operate if a slide lock is open, and the status LED will flash orange to indicate this condition.

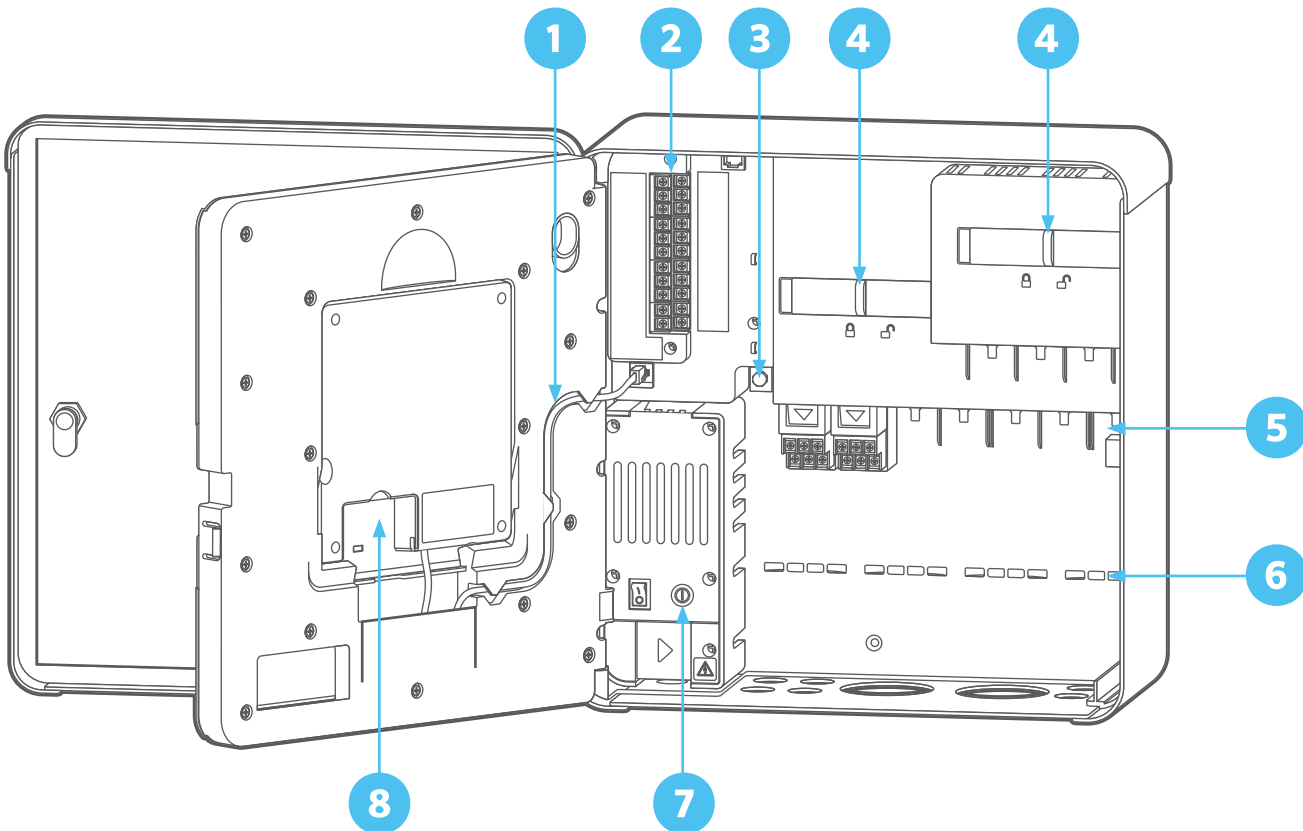

FLOW EXPANSION

A2C-F3 flow expansion modules add 3 additional flow inputs to the controller. These modules may only be added to the lower right module slot, one per controller, and it is the only module that will fit in this slot.

The flow expansion module has DC voltage and polarity, and the + or red connection from the flow sensor must be connected correctly to the + (positive) terminals on the module. Finish flow expansion in the Devices, Flow Sensors menu after installing the module.

WIRE TIE HOLDERS

Wire tie holders are molded into the lower back of the wiring compartment to secure field wiring with plastic “zip” ties. This provides a strain relief to keep field wires from pulling downward on the modules, and keeps the inside neat and organized.

Additional wire tie holders are provided near the Power Supply Board for sensor and other connections.

TRANSFORMER FUSE

The transformer uses a replaceable 5 x 20 mm electrical fuse, located next to the convenient on/off switch. Two spare fuses are stored in the bottom rear of the facepack frame.

Replacement fuses shall be glass body 5 x 20 mm 250V, 2A fast blow, commonly available wherever electronics are sold.

OPTIONAL WI-FI OR LAN

The Wi-Fi or LAN slot allows installation of optional communication modules.

Operating the Controls

ACC2 has a simple control panel with unique operating features.

1. The dial is used to rotate through selections and then pushed to select, or to enter information.
2. To the right of the LCD display are 4 “soft” keys. Their functions will change with each menu selection, as shown in the ACC2 display.
3. Back always goes back up a level from the current menu selection.
4. Home will always return you to the Home screen view.

Home screen shows the status of the controller, including anything currently running in the field. When in the Home screen, the bottom soft key is called Main Menu, and this takes you to all programming and setup functions.

From the Main Menu button, you may enter the setup menus for all ACC functions. Turn the dial to view the main menus, and press the dial to select one of them. Then, use the dial to select the items within that menu. Press to select one.

Once you’ve entered a programming screen, use the dial to navigate through all the fields of information. Press to select one, rotate to see the choices or to enter numbers or letters, and press to select.

Press Home at any time to return to the top level, or to navigate to other functions.



Attention Messages

A new controller installation will begin with at least one or two Attention messages, because the controller has experienced a “power outage” in shipping, and may be discovering new modules. This is normal.

Messages on the screen do not interfere with normal irrigation.

START UP SCREEN

When power is first turned on (either with the power switch, or closing one of the slide locks), the Hunter logo screen appears, and the controller begins searching for any irrigation events it may have missed during a power outage.

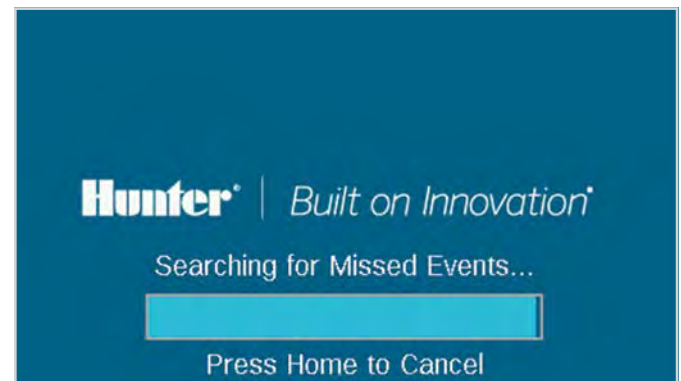

This search can be canceled if you are installing or servicing the controller by pressing the Home button on the facepack.

If the controller finishes searching for missed events (about 1 minute), it will resume irrigating where it should be at the current time of day.

In automatic operations, the controller will always perform the search after any power outage. Watering that was missed during the outage will be recorded in the logs, and the watering will resume where it should be at the time of the power restore.

VIEW MESSAGES

A flashing alarm symbol at the bottom of the display indicates that something unusual has been detected. When the symbol is flashing, a soft key will link to View Messages. Press the key to view the most recent messages in the Attention screen.

From the Attention screen, you can View Logs, to get more details about the messages, and/or Clear Messages, to return to the Home screen.

CLEAR MESSAGES

Attention messages in the display can be cleared by pressing the Clear Messages soft key, after pressing View Messages. The message will still be available in the controller's logs.

Attention messages do not prevent watering or normal operation. However, they may announce a condition that can prevent or affect watering.

VIEW LOGS

Press View Logs for more detailed information about each message.

The soft keys will link to the Alarm, Controller, and Station logs when an attention message is displayed. The Filter Logs function will allow you to search for logs on a specific date, or by record number. You can also access logs at any time from the Diagnostics menu.

Home and Activity Screens

The Home screen offers basic information and soft key shortcuts to common functions.

System status is shown in the upper right.

Current date and time are displayed in the bottom left border.



If Solar Sync is installed and enabled (Devices menu), the Solar Sync symbol shows the current adjustment percentage in the lower right of the border.

If the red/white ! triangle symbol flashes in the lower right corner, the controller has detected an important situation. A soft key will change to View Messages, for more information about the condition. The messages screen allows you to clear a message or select View Logs for more details. Messages on the screen do not interfere with normal irrigation.

If sensors are active (alarmed), this is shown in red text in the upper right corner.



ACTIVITY SCREEN

When the controller is running stations, the Home screen becomes the Activity screen, with additional information and functions.

All running stations are displayed, along with the program that is running them, the mode in which they are running, and the amount of run time remaining on the station.

Individual items may be selected directly from the Activity screen and stopped without affecting other irrigation. [See Selective Stop section on page 14.](#)

System: RUNNING			
Station	Pgm	Mode	Remaining
1	1	Auto	00:01:41
2	1	Auto	00:01:43
3	1	Auto	00:01:45
4	1	Auto	00:01:47
9	2	Auto	00:01:52

09:00:22AM
Thursday, 9/22/2016

Stop
Manual
View Flow
Main Menu

The soft keys normally show Stop, Manual, View Flow (shows current flow if a flow sensor is installed and enabled), and Main Menu. Stop and Manual are described in the Basic Programming section. View Flow is described in detail in the Flow Operations section.

Basic Programming and Setup

NAMES

ACC2 allows items to be named, with an on-screen keyboard that appears in the Name field (or from a mobile device, if the optional Wi-Fi module is installed). Names are useful in large systems, especially in the more advanced Flow Operations.

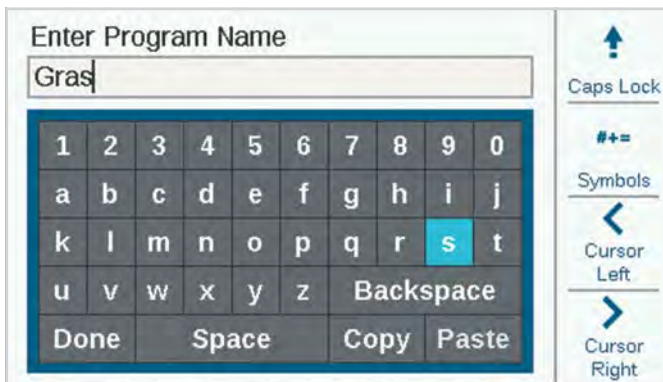

Select the Name field for any of these components, and a keyboard will appear to enter an alpha-numeric name.

Items that can be named are:

- Programs
- Stations
- Blocks
- Klik Sensors
- MainSafe™ zones
- Flow Zones

SETTINGS, TIME AND DATE

From the Home screen, press Main Menu, and dial to Settings. Select Settings, and dial to Regional Settings.

Choose language, time and date formats, and units of measurement. Press Back or Home to exit.

From the Settings menu, choose Time/Date: Set the current time and date, and also Daylight Saving options. Press Back or Home to exit.



PUMP/MASTER VALVE SETUP

From Main Menu, dial to the Stations menu. Set Station P/MV Usage for each station, if necessary.

P/MV outputs 1 through 3 always refer to the output terminals on the Power Supply Board. P/MV outputs 4, 5, and 6 can be assigned to regular station outputs. [See Soft P/MVs on page 12.](#)

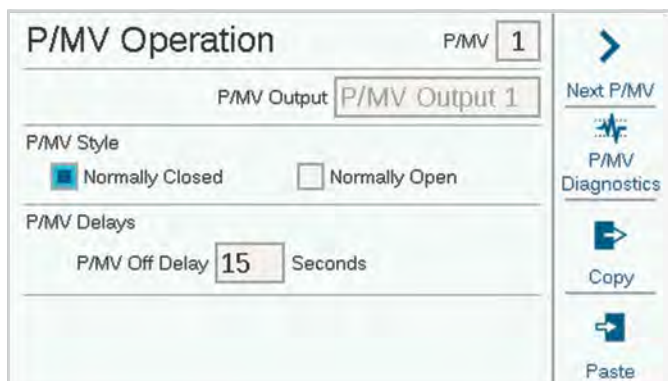

All P/MV outputs are set to Normally Closed operation, but they can be changed to Normally Open functions in the Devices menu. [See P/MV Operation section on page 18.](#)

The flow settings on this screen are not necessary for basic operations.

SOFT P/MVS (4-6)

P/MV outputs 4 through 6 will show as “Disabled”, unless you select one of the station outputs to be used as an additional P/MV.

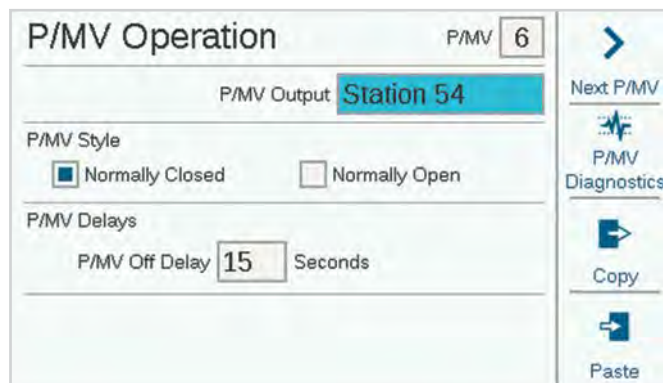

These are called “soft P/MVs”. Once a station is designated as a P/MV, that is its only function, and it must not be included in irrigation programs as a “regular” station.

MANUAL STARTS AND TEST

On the Home screen, the Manual soft key lets you start stations, programs, or a test program. Once you press Manual, there are three choices:

Run Manual Stations

Manual Run Type
 Sequential Simultaneous

Manual Run Events

Run Type	Number	Run Time HH:MM :SS
Station	30	00:05 :00
Station	27	00:08 :00
Station	36	00:06 :00

Start
Delete
Insert Line
Fill Down

MANUAL STATIONS

Specify one or more stations to run and enter a run time for them. You can also choose to run them simultaneously, rather than sequentially, if you check the Simultaneous box. Press the Start key to start the list.

MANUAL PROGRAM

Select a program number to start, and press the Start key to start it. It is also possible to scroll down to an event in the program, and start the program from that point forward.

A Manual Station or Program Start will pause any automatic watering until the Manual Program has completed.

TEST PROGRAM

The Test program will run all stations in the controller for the Run Time entered on the screen. It is also possible to specify a station number, and run all remaining stations from that number to the highest numbered station.

STOP COMMANDS

Any running irrigation can be stopped immediately from the Home screen. The top soft key offers the following choices for stopping irrigation:

System: RUNNING

Station	Pgm	Mode	Remaining
47	6	Auto	00:01:05
36	5	Auto	00:00:31
40	5	Auto	00:00:33

09:09:11AM
Monday, 1/30/2017

Stop All Irrigation
Timed Off
Pause
System Off

STOP ALL IRRIGATION

Stops everything that is watering or running immediately. The controller is still in automatic irrigation mode, and will resume watering at the next start time.

TIMED OFF

Like System Off, this stops all stations, and prevents automatic irrigation, but for a specified period of days. When the days have counted down to zero, the controller will resume automatic operations.

PAUSE

Interrupts whatever is currently running, until either Resume is pressed, or 30 minutes have passed. Anything running will be resumed where it left off, and run for its remaining time. When items are paused, the Resume button will appear.

Pause freezes all irrigation, including pending events. When the controller resumes, all remaining events will be pushed back for the amount of time the system was paused. This will cause irrigation to end later than usual.

SYSTEM OFF

This turns off all irrigation, and places the controller in permanent Off mode. No automatic irrigation will occur.

STOP COMMANDS (CONTINUED)

SELECTIVE STOP

You can also use the dial to scroll through the list of running stations and programs on the Home screen and click to stop any one of them instead of the entire list. If you highlight an active station, the Stop button will allow you to Stop Station, or Stop Program. Stop Program will stop the entire program that caused the station to run, but allows other programs to keep running.

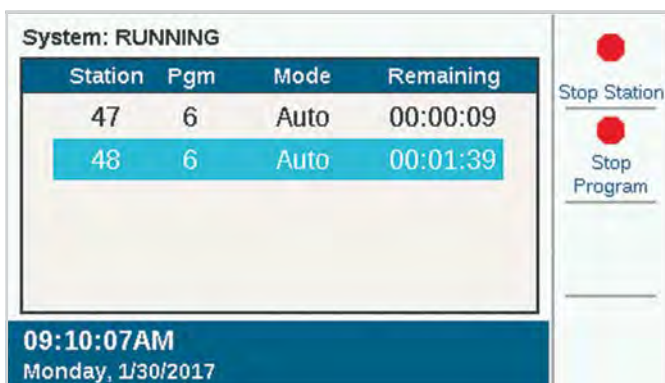

PROGRAMS

From Main Menu, dial to the Programs menu and select. This is where basic automatic irrigation is set up.

A basic program requires Start Times, Run Times, and Water Days to operate automatically. There are 32 possible automatic irrigation programs, each with up to 10 Start Times.

START TIMES

Verify that you have the correct program number, or select and enter the program you want.

- **Name (optional):** You may enter a name for the program if you wish.
- **Run Mode:** Must be set to Auto to run automatically.
 - **Manual Only:** does not water automatically, but stores station run times for manual irrigation only. These programs do not have day schedules or start times. They may be changed to Auto mode at any time, if automatic operation is desired.
- **Stack or Overlap:** Stack means the program must run by itself. Overlap means it is allowed to run at the same time as other programs. If a program is stacked, its actual start time may change, if other programs overlap it in time.
- **Auto Start Times:** Enter the time for the program to start. The faster you rotate the dial, the faster the times will change. Each program may have up to 10 start times.

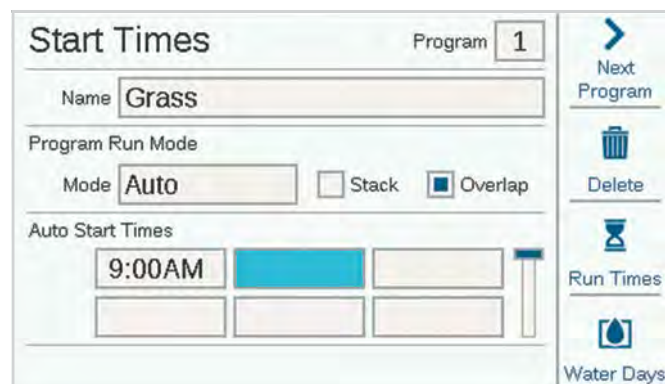

INTELLIGENT CURRENT SENSING

ACC2 has no artificial programming limits preventing overlapping programs and stations. The controller senses how much electrical current is being drawn, and will suspend stations automatically if the combined current threatens the transformer.

It is also possible to set controller and station limits (Stations, Station Limits) to control how many outputs may operate at once.

A conventionally wired ACC2 may run as many as 14 Hunter solenoids (including any P/MV outputs) simultaneously before suspending additional stations. Environmental factors or higher-draw solenoids may cause the overcurrent protection to activate at lower station counts.

It is possible to view the current draw of each station in the Diagnostics menu.

RUN TIMES

You can access Run Times from the programming menu, or from the soft key shortcuts from the Start Times screen. This allows you to set up an entire program (start times, run times, and water days) from the same menu.

Run Type	Number	Run Time HH:MM :SS	Adjusted Run Time
Station	1	00:10 :00	00:08:30
Station	2	00:12 :00	00:10:12
Station	3	00:10 :00	00:08:30

Adjusted Total Run Time **00:35** Seasonal Adjust **85%**

Verify that you are in the correct program, by number or name.

Select the Run Type field, and select Station or Block (“Blocks” are described in detail in the Stations Menu section. Blocks replace “SSGs” in the original ACC). Press the dial to select the type.

Dial to the Number field. Press and dial to select station or block number. Press to enter.

Dial to the Run Time field, press to select, and dial to enter the run time (from 1 minute to 12 hours). You can also enter run times in seconds, by dialing to the: SS field (seconds), which is adjusted separately.

You may continue to enter any station numbers, in any order, in the same way.

Show Edit Tools (Shortcuts): Press the soft key for Show Edit Tools. If you are running stations in numerical order, you can use the soft key for Fill Down. This will automatically add 1 to the previous station number, and copy the run time on the next line. For example, if you entered Station 1, 5 minutes, and then pressed **Fill Down**, it would add Station 2 for 5 minutes on the next line. This is a shortcut for copying sequential run times very quickly.

You can also **Delete** any item from the list. Scroll to the item, and press Delete.

You can also **Insert** an item above any selected line in the list. Scroll to an item, and press Insert Line, and a blank line will appear above it.

ACC2 can run any station or block in any order. Example: you could insert station 3 between stations 1 and 2. The program would run 1, 3, 2, in that order.

Adjusted Run Times: The Adjusted Run Times show the effects of the current Seasonal Adjust settings on the base run time. If a run time is set to 10 minutes, but Seasonal Adjust is at 50%, the Adjusted Run Time will show 5 minutes. The Seasonal Adjust amount is not changed in this screen, but can be set from the Programs menu, or automatically by a Solar Sync sensor.

When all the Run Times for the program have been set, press Back or Home to exit.

WATER DAYS

Verify you are in the correct program by number or name, and set the days for automatic watering.

Mode selects a type of schedule.

- **Day of Week:** Check the boxes for the days the program should water.
- **Odd/Even:** Water only on odd or even calendar dates, to comply with water restrictions. An optional check box allows skipping the 31st day of the month.
- **Interval:** Water every x number of days, regardless of the day of week. Enter the desired interval days.

Both Odd/Even and Interval also have Non Water Days, which can set a day (for example, a mowing day) on which watering will never occur, regardless of the schedule.

SEASONAL ADJUST

Programs menu, Seasonal Adjust.

When using Solar Sync, set up at Devices page first, then go to Seasonal Adjust.

- **Seasonal Adjust Mode:** Set a percentage adjustment to all run times by Controller or Program, or set a Monthly schedule for the controller to follow automatically, or assign the program to Solar Sync automatic adjustment.
- **Controller:** The Seasonal Adjust value will follow whatever has been set for the controller level. All programs set to Controller will receive the same manual adjustment.
- **Program:** The Season Adjust factor entered here will only apply to the selected program, and is not affected by other adjustments.
- **Monthly:** Enter in advance the adjustment value for each month of the year (usually based on historical weather averages). These adjustments take effect automatically on the 1st of each month, and do not change during the month.
- **Solar Sync:** Adjustments are made to the selected program automatically by a Solar Sync sensor attached to the controller. This requires a sensor, and setup at the Devices menu, Setup Solar Sync.

Each Program must have a Seasonal Adjustment set. **Copy** and **Paste** shortcuts permit copying the initial setup, and then pasting it to all similar programs.

PROGRAM RULES

Program Rules customizes each program for special purposes.

Program Rules Program **2**

Name **Shrubs**

Ignore Calendar Days Off

No Water Window Start **10:00AM**

No Water Window End **9:15PM**
(HH:MM:SS)

Station Delay **00:00:08**

Next Program
Delete
Copy
Paste

IGNORE CALENDAR DAYS OFF

Check the box if the program should be allowed to run on Calendar Days Off that apply to other programs.

NO WATER WINDOW (START AND END)

Enter start and end times for the portion of the day during which automatic irrigation is never allowed. Program will never be allowed to run during this period, although Manual operations will be allowed. If a program is suspended by a No Water Window, it will be logged as an alarm, for corrective action.

STATION DELAY (DELAY BETWEEN STATIONS)

Sets an interval between each station in a program. This can be used for slow-closing valves, recharging pressure tanks, etc. During the delay, the P/MV output will continue running for 15 seconds, unless this is adjusted in the Devices, P/MV Operation screen.

CALENDAR DAYS OFF

Create a list of dates on which the whole controller will not be allowed to run, regardless of Water Day settings. Programs that have been set to Ignore Calendar Days Off in the Program Rules screen will be allowed to run anyway.

Calendar Days Off

Add Calendar Day Off

Dec 18, 2017 **Add**

Calendar Days Off

Jul 4, 2017	Aug 15, 2017
Dec 18, 2017	

Delete

PROGRAM SUMMARY

Once a program has start times, run times, and water days, it will run automatically without further setup. To see how the program is configured, select Program Summary from the Programming screen.

Program Summary Program **2**

Name: **Shrubs**

Mode: **Auto**

Stack or Overlap: **Overlap**

Water Days:
- **Mon Tue Wed Thu Fri Sat Sun**

Number Of Starts: **1**

- **9:00AM**

Adjusted Run Time(HH:MM): **00:14**

Seasonal Adjust Value: **85%**

No Water Window: **10:00AM - 9:15PM**

Next Program
Controller
Programs
Graph

The summary will show the total number of programs ready to run for the entire controller.

Press the **Programs** soft key to view details for each program.

Press the **Graph** soft key to view a chart of all programs occurring over time. Turn the dial to view the graph up to 7 days in advance.

Non Water Windows and Calendar Days Off options will show on the graph in red as **Water Restrictions**, meaning automatic irrigation cannot occur during those periods.

P/MV OPERATION (PUMP/MASTER VALVE OPERATION)

Dial to the Devices menu, and select P/MV Operation. Each P/MV will be checked for **Normally Closed** operation. This is a station level setting, meaning that the P/MV is activated by stations when they begin to run. The Station Setup menu allows you to set each station for the P/MV outputs it needs to run water.

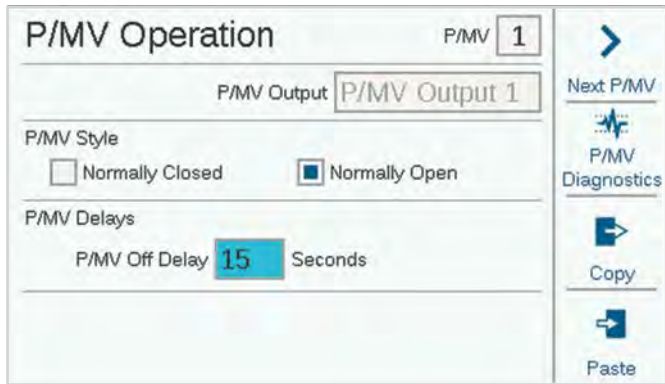

Normally Open may also be selected, and is discussed further in the Flow Operations section. Normally Open is not a station level setting. The valve is always open until a problem is detected at the Flow Zone, or MainSafe level, when the controller activates the normally-open P/MV to shut the water off.

P/MV Off Delay: This sets how long the P/MV output will remain active after a station stops calling for it (for example, during Delay Between Stations). It is preset to 15 seconds, but can be changed (use caution). Hunter is not responsible for damage to pump components when longer delays are set.

P/MV Diagnostics: Press the soft key for P/MV Diagnostics to view the status and current draw of each active P/MV output. P/MVs that are not running are not shown.

SENSORS

Rain shutoff and other sensors must be setup in the Devices menu.

CLIK SENSORS

Dial to the Devices menu, and select Clik Sensors for basic Hunter “Clik” sensors.



To set up a sensor, click the box for Enable Sensor.

The ACC2 sensor inputs are already configured as Normally Closed, but this can be changed for other types of contact-closure sensor inputs to Normally Open.

It is also possible to enter a name for individual sensors.

SENSOR RESPONSE

Located on the Devices menu, Sensor Response sets which sensors will shut off which programs in basic operations.

The sensor responses are set up for each program, one page at a time. If you want the same responses for multiple programs, set up the responses for the first program, then click the Copy soft key. You can then change the program number and click the Paste soft key to duplicate the settings.

Sensor Response		Program 2
Name	Shrubs	
Clik Sensor 1	Suspend	
Clik Sensor 2	Ignore	
Clik Sensor 3	Ignore	
Solar Sync Rain	Suspend	
Solar Sync Freeze	Ignore	

There are three standard Clik sensor inputs on the Power Supply Board. If a Hunter Solar Sync sensor has been configured, there are also settings for Solar Sync Rain and Freeze.

Ignore: Program does not respond to the sensor.

Suspend (recommended): Program suspends watering when sensor is active (alarmed) but keeps track of time. If the sensor returns to normal, the suspended program will resume irrigating where it should be at that time in the schedule. The program will end when it was originally scheduled to end.

Pause (use caution): Program stops where it is, when the sensor is active. If the sensor returns to normal, the program will resume watering where it left off. This will cause the program to end much later than the original schedule.

It is not possible for a program to be set to both Pause and Suspend for different sensors, because they cannot both be active at the same time. If you change a response setting for a sensor, and another sensor for the same program changes automatically, this is by design.

Sensor Response	
Days to Wait After Reset:	
Clik Sensor 1	3 Days
Clik Sensor 2	None
Clik Sensor 3	None
Solar Sync Rain	2 Days
Solar Sync Freeze	None

Rain Delay: In the Sensor Response menu, press the soft key for Rain Delay. This optional setting will cause watering to stay off for a set number of days after the sensor activation is over. Select the number of days for watering to stay off for each Clik sensor input.

SOLAR SYNC

After connecting a Solar Sync sensor to the controller, set up operation in the Devices, Solar Sync menu.

- Check the box to Enable Solar Sync.
- Choose the Region and set the Water Adjustment, according to the Solar Sync manual instructions.
- For normal operations, this is all that is necessary. It will take the Solar Sync two or three days to register enough climate data to begin adjusting.

Solar Sync Delay allows a number of days to wait before automatic Solar Sync adjustment goes into effect (to establish new landscape, for example). Enter a number of days (1-250) to wait, and specify the **Adjustment During Delay** percentage to use during the delay period. At the end of the delay, the Solar Sync will begin adjusting automatically for the current climate conditions.

The delay does not interfere with the Solar Sync Rain and Temp functions. They are still able to perform shutdowns on rain or freeze events during this delay.

Complete the setup by setting the programs to use Solar Sync in the Program, Seasonal Adjust menu.

FLOW SENSORS

After connecting one or more flow sensors to the controller, set up operation in the Devices, Flow Sensors menu.

Select the sensor input number to be setup (1-6). The controller has 3 Flow Sensor inputs built in, but 3 more can be added with the A2C-F3 Flow Expansion module.

Check the box for either “Hunter” or “Other” flow meters.

If **Hunter** is checked, move to the Model field and select the Hunter FCT model number for the diameter of the pipe. This is all that is necessary to calibrate the setup.

If **Other** is checked, you must select the Flow Sensor Style and enter the calibration information. Some use K-factor and Offset, and others are Pulse type. Consult the flow meter supplier’s documentation for the correct settings or contact Hunter Technical Support for additional information.

K-Factor and Offset: obtain these values from the flow sensor manual, and enter here.

Pulse type: enter the amount equal to a single pulse.

Enter the information for each flow sensor that is connected to a flow terminal. There are copy and paste soft keys available, if all the meters are the same type and size.

Once this information is entered for each flow sensor input, the controller is ready to read flow. However, each flow sensor must be attached to a Flow Zone (Flow, Flow Zones) before real time monitoring can occur.

Flow Totals may be viewed at the Flow menu.

Current flow rates (by sensor) can be read from the Home/Activity screen with the View Flow soft key.

Flow Monitoring: Additional setup for station level flow monitoring is required in the Flow menu (Flow Zones), and in the Stations, Station Setup menu.

Stations Menu

STATION SETUP

Allows stations to be named. Most other functions are described in more detail in the Flow Operations section.

Station P/MV Usage indicates which normally-closed P/MV outputs the station will activate, whenever it runs.

Station **Flow Zone** assignment (required for Flow Manager and/or Flow Monitoring).

Flow Priority (used in Flow Manager). Check the box to make a station more likely to water earlier in flow management.

Flow Rate: Enter or learn the typical flow for the station. Used in both Flow Manager and Flow Monitor. *See Flow Operations section on page 32.*

Delay: Sets the amount of time the station can run before high or low flows will cause an alarm. Set longer delays for stations that take longer to stabilize flow.

P/MV boxes with the “X” are unavailable, because they are already assigned to other Flow Zones or MainSafe™ zones.

CYCLE & SOAK

Used to control runoff and puddles when soil or slope cannot absorb all irrigation at once.

Set the Cycle to the maximum time the station can run at once, before runoff occurs.

Set the Soak to the minimum time the station must wait before applying another cycle. The controller will water other stations during the Soak period. For this reason, Cycle & Soak generally does not extend the overall watering time significantly.

The copy and paste shortcuts allow quick duplication of these settings to stations with similar characteristics.

BLOCKS

A Block is an electronic group of stations that runs at the same time, for the same run time, within a program (Blocks replace “SSGs” in original ACC).

The screenshot shows a configuration window for 'Block 1'. At the top right, it says 'Block 1' with a blue square containing the number 1. Below this is a text field for 'Name' containing 'Block 1'. Underneath is a 'Stations' section with a 2x4 grid of boxes. The first row contains boxes with the numbers 16, 31, and 49. The second row contains four empty boxes. Below the stations is a 'Cycle & Soak' section with two rows: 'Block Cycle Time' set to 0:15 (H:MM) and 'Block Soak Time' set to 0:30 (H:MM). On the right side of the window, there is a vertical toolbar with four buttons: 'Next Block' (a right-pointing arrow), 'Delete' (a trash can icon), 'Copy' (a right-pointing arrow with a document icon), and 'Paste' (a left-pointing arrow with a document icon).

To create a Block, dial to the Stations menu and select Blocks. Enter a name for the Block if you wish.

Dial down to the station spaces, click and enter the station numbers that will be in the Block.

Blocks may also have their own Cycle and Soak settings.

- Blocks may have up to 8 stations each.
- There can be up to 64 blocks per controller.
- They can be mixed in a program with individual stations.
- Programs with blocks are not limited in any way by other programs that are running. The controller will not turn on more stations than it can handle, so there are no artificial rules governing the blocks.

STATION LIMITS

Station Limits set how many stations can run at once.

Stack or Overlap means that each program can be manually set to overlap with other programs, or be required to stack. Programs that are set to stack can only run by themselves.

SmartStack specifies a maximum number of programs that are allowed to overlap across the whole controller.

Maximum Simultaneous Stations is the total number of simultaneous stations that can occur for any reason in the entire controller. This is mainly for use with the Flow Manager, but applies to all situations.

If Flow Manager is enabled, the display will also show **Program Limits**. This sets the max number of stations that can run within any one program. This might be used to force irrigation to be spread over a larger number of programs, when Flow Manager is scheduling stations on to reach a flow rate target.

STATION SUMMARY

The Station Summary is a report available for each station showing exactly how it is going to run, based on the current setup and programming. It is a report only, and does not allow changes to be made directly from this screen.

Devices Menu

Devices allows setup of common external devices that the controller can use. The functions in the Devices menu are covered in more detail in other sections.

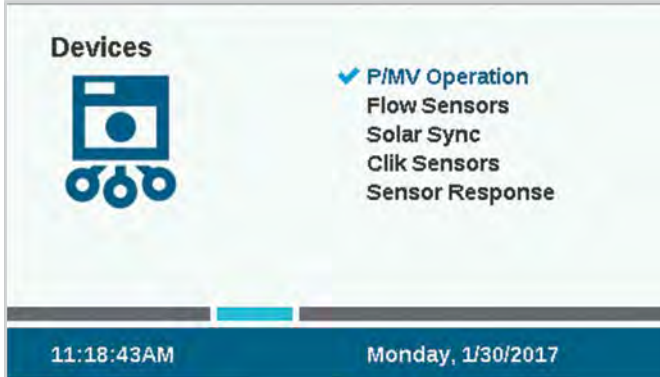

P/MV OPERATION

Set the Style, Normally Closed or Normally Open, for the Pump/Master Valve outputs.

Pumps should always be set to Normally Closed to prevent damage.

The P/MV Delay sets how long the P/MV will remain active if a station pauses, such as during the delay between stations.

FLOW SENSORS

Flow Sensor setup is covered in detail in the Basic Programming, Sensors, and [Flow Sensors section on page 20](#).

SOLAR SYNC

Solar Sync setup is covered in detail in the Basic Programming, Sensors, and [Solar Sync section on page 20](#).

CLIK SENSORS

Clik sensor setup is covered in detail in the Basic Programming, Sensors, and [Clik Sensors section on page 18](#).

SENSOR RESPONSE

Sensor Response is covered in detail in the Basic Programming, Sensors, and [Flow Sensors section on page 20](#).

A sensor response setting is required for any sensor to be able to shut off any program in the controller.

Flow Menu

The flow menu includes all setup for the various flow functions. These are described in detail in the [Flow Operations section on page 32](#).

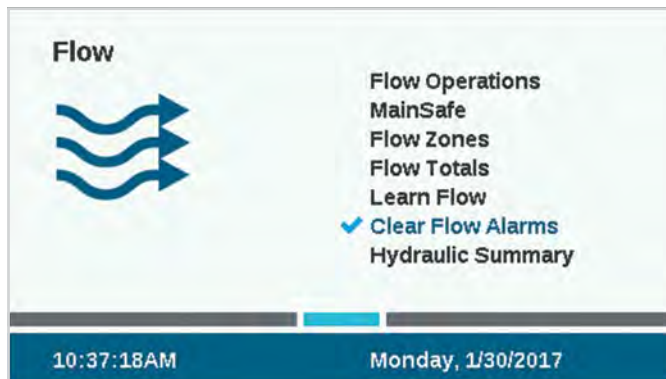

CLEAR FLOW ALARMS

The Clear Flow Alarm function enables a MainSafe or Flow Zone that has had an Overflow alarm to water again. If a Flow Zone or MainSafe flow alarm has occurred, a shortcut key is provided on the Home screen to Clear Flow Alarms.

If the **Alarm Clear Delay** is set to **Manual Only**, a user must manually clear the alarm with this function before it can water again.

If Alarm Clear Delay is set to a time in HH:MM format, the controller can run irrigation in the MainSafe or Flow Zone automatically again, after the time has elapsed.

Settings Menu

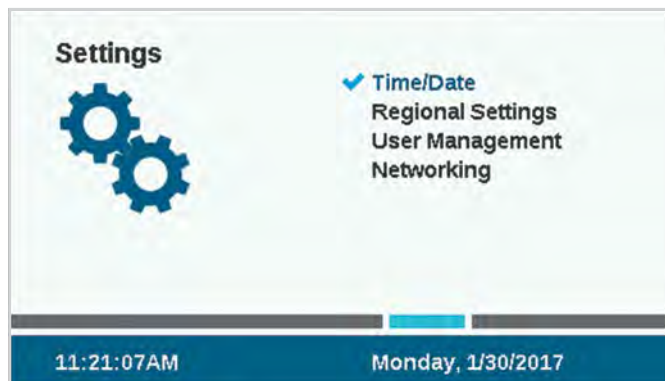

TIME/DATE

Sets time and date, see Basic Programming, and [Time/Date section on page 25](#).

REGIONAL SETTINGS

Sets Regional preferences, see [Basic Programming section on page 11](#).

USER MANAGEMENT

This allows a password to be created for the controller. Users will be required to enter the correct PIN (personal identification number) before operating the controller. If a single PIN is entered at the top, it is required for all users, and provides the same level of access to all.



If passwords are enabled, and the password is lost or forgotten, you will be locked out of the controller.

Check the box for Enable User Management to create one or more PINs. Once it is checked, only an Admin level user who is successfully logged in may uncheck this box.

Edit User

Name: Ed Waterman

User Type:
 Admin
 Crew

User PIN: 0001

Buttons: Cancel, Save

It is also possible to define different users, and individual PINs.

User Management

Disable User Management

User List

Name	Type	PIN
John Washrack	Crew	0002
Ed Waterman	Admin	0001

Buttons: Delete User, Add User

There are two levels of authorization, Admin and Crew.

Crew level access allows manual operations and the ability to view programming.

Only **Admins** may modify programming and other settings.

User log-ins are tracked in the Controller Log.

To add a user, press the soft key for Add User. You may then enter the user's name with the keyboard that appears. For each user, select the Type (Admin or Crew), and create a unique PIN for that person.

It is also possible for an Admin to delete users with the Delete User soft key.

Users will be automatically logged off after 30 minutes of inactivity.

NETWORKING

If the internal Wi-Fi or LAN modules are installed, Networking will display the network settings of these devices.

Wi-Fi Setup: This soft key lets you specify either direct or central communications. Direct connections from a smart mobile device will allow remote control, text entry, and flow reporting within the range of the mobile device.

Network: This option is not currently enabled.

Diagnostics Menu



Attention messages do not interfere with normal automatic irrigation.

All attention messages on the Home screen create logs. The first step to understanding any problem or message is to click the soft key for View Logs, or access the logs from the Diagnostics menu.

Other helpful tools are also located at Diagnostics.



VIEW LOGS

There are 3 types of logs, and a filter function to narrow the number of logs displayed.

ALARM LOGS

The controller will store up to 250 alarm logs, with date and time, beginning with the most recent alarm. Use the dial to advance forward and backward through the alarm list.



CONTROLLER LOGS

Other significant messages that are not technically alarms are stored in the controller logs (up to 250 events). They are also arranged by date and time, with the most recent log first.

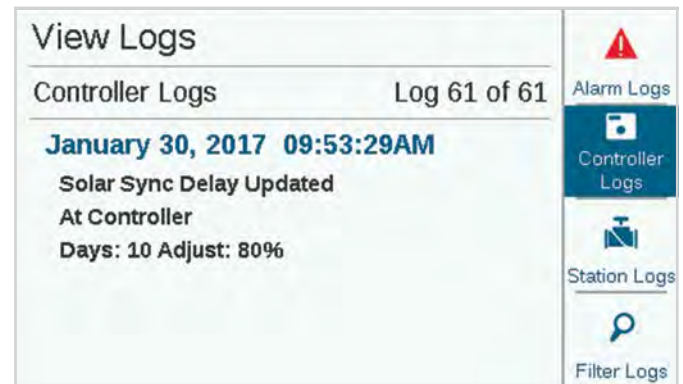

STATION LOGS

Station logs record every single event that occurs in the controller (up to 1500 events), beginning with the most recent. This can be useful for advanced troubleshooting, or to verify that a station actually watered.

FILTER LOGS

This allows any of the three logs to be filtered by date, or by record number.

EXPORT LOGS



All logs can be written to the SD card, described in the Advanced Features section. [Advanced Features section on page 30.](#)

MODULE INFO

Select Module Info to see the current version of all firmware in all modules and components. Module slots or components that are empty or not reporting are shown as Not Present.

Soft keys allow shortcuts to other diagnostic checks, which are also available directly from the Diagnostics menu.

When the facepack is reversed in the frame, it will automatically go to the Module Info screen. The facepack is still fully operational, and pressing the Home button can access all programming functions when the facepack is reversed. The controller will still run automatically if the facepack is left reversed.

Module Info

Facepack	0.38.000 A
Power Supply Board	0.15.001 b
Station Modules:	
Slot 01 (Stations 1-6)	0.06.002 b
Slot 02 (Stations 7-12)	0.07.003 b
Slot 03 (Stations 13-18)	0.08.004 b
Slot 04 (Stations 19-24)	0.09.005 b
Slot 05 (Stations 25-30)	0.10.006 b
Slot 06 (Stations 31-36)	0.11.007 b
Slot 07 (Stations 37-42)	0.12.008 b

Clik Sensor Diagnostics

Station Diagnostics

Flow Sensor Diagnostics

Solar Sync Diagnostics

CLIK SENSOR DIAGNOSTICS



- **Sensor:** Shows each sensor and name.
- **State:** Shows the current status of the sensor.
 - **“Inactive”** means the sensor is normal.
 - **“Active”** means the sensor is currently alarmed.
 - **“Delayed”** means the sensor was recently alarmed, and is now inactive, but a Rain Delay is in effect for the sensor.
 - **“Disabled”** means the check box for the sensor (Devices menu) is unchecked, and no responses will be caused by the sensor.
- **In Use?:** Shows whether the sensor is currently set to shut down any programs in the Sensor Response menu.

Clik Sensor Diagnostics

Sensor	State	In Use?	Setup Clik Sensors
1: Clik Sensor 1	DELAYED 72 Hours Remaining	Yes	
2: Clik Sensor 2	INACTIVE	No	
3: Clik Sensor 3	INACTIVE	No	

STATION-P/MV DIAGNOSTICS

Shows the electrical current draw in milliamps for all active stations and P/MV outputs.

Station-P/MV Diagnostics		 P/MV Operation
Transformer Output: 26.0VAC 560mA		 Station Setup
Active Station-P/MV	Current Draw	
P/MV 5: Station 53	0mA	
P/MV 6: Station 54	0mA	
24: Station 24	224mA	
25: Station 25	225mA	
26: Station 26	226mA	
27: Station 27	227mA	

FLOW SENSOR DIAGNOSTICS

Shows the configuration of each flow sensor and current flow. Frequency shows the click or pulse rate from the sensor, for diagnostic purposes.

Flow Sensor Diagnostics				 Setup Flow Sensors
Number	Sensor Type	Flow Rate	Frequency	
1	HFS FCT-400	56 GPM	6 Hz	
2	HFS FCT-200	21 GPM	10 Hz	
3	HFS FCT-200	30 GPM	14 Hz	
Flow Module Installed: No				

SOLAR SYNC DIAGNOSTICS

Shows the last time the Solar Sync sensor communicated, and the current state of its alarm sensors (Rain and Freeze). This soft key is only shown if Solar Sync has been set up in the Devices menu.

The **Test Connection** soft key checks for the presence of a wired sensor, or for the presence of the receiver for a wireless sensor. Test does not initiate communications to the wireless sensor itself, because it is a one-way connection.

Advanced Features



EXPORT LOGS

Logs may be exported in a simple text format to the internal SD card in the facepack if additional help is needed for troubleshooting, or just for record-keeping purposes.

Enter a unique file name by clicking in the File Name box.

Select the boxes for the types of logs desired.

Select and click the Export Logs button to save the file to the SD card. The card may then be inserted into a computer or other device with SD card reader, and saved or sent to another location.



EASY RETRIEVE

Saves the current controller setup, so that it may be restored to this point at a future date.



Controller Memory: Only one setup may be saved in controller memory, and it will remain unless you make changes and create a new Easy Retrieve backup in the future. You can choose Restore at any time, and it will change the whole controller to the last Easy Retrieve backup.

SD Card File: You can also save Easy Retrieve backups to the SD card via the SD card slot in the facepack (to do this, an SD card must be installed). You may also restore from the SD card to any saved Easy Retrieve in the future.

When saving to SD card, you must enter a name for the file. Click to select the File Name, and a keyboard will appear. Enter the name for the file, and choose Done from the keyboard when complete.

Using the SD card and different file names allows you to save as many backups, under different names, as the card will hold. You can restore any one of them from the SD card by entering the correct file name. The SD card cannot display a list of the saved files, so be sure to enter the file name exactly as it is saved on the card.

RESET MEMORY

Sometimes it is preferable to simply erase the controller, to begin again from a clean start. There are several reset options.



All Programming and Devices: Erases all programs and device setups, but keeps the Flow Totals intact.

This will require completely reprogramming all devices, flow setups, and irrigation schedules.

Flow Totals: Clears the flow total history and resets all to 0.

Check the boxes for the items you wish to clear, and press Delete. The controller will ask if you are sure, before erasing data.

FIRMWARE UPDATE

ACC2 can be updated whenever a new version of the operating system or any of the internal modules is released. These updates are usually available from www.hunterindustries.com, or are sent via email. It is always advisable to stay current with controller updates.

Copy the update files onto a compatible SD card, and insert in the SD card reader.

Select Firmware Updates from the Settings menu. The controller will detect and display available updates on the card.

Press the soft key for Update, and the files will be copied to the controller. Wait until the automatic reboot is complete, and the controller will be up to date.



Do not turn off power to the controller or facepack once the update has started. Damage may result.

CONDITIONAL RESPONSE

Conditional Response allows active responses to various sensors or other conditions. It can be used to:

- Start a station, block, or program based on a sensor input
- Switch P/MV outputs based on a switch position
- Activate an external light (SOS) to indicate an alarm in the controller

Read the *Conditional Response section on page 31* before using these features.

Flow Operations

The two major parts of Flow Operations are the Flow Manager, and the Flow Monitor.

Checking either will display a reminder of the steps for setting these features up. Press the soft key for Continue to setup the selected function.



FLOW MANAGER

Flow Manager uses station flow information to run simultaneous stations to reach a flow rate target that is specified by the user. It will turn on as many stations as it can to stay at or near the flow target until there are no more stations to run. This does not require a flow sensor input.

FLOW MONITOR

Flow Monitor verifies that actual flow matches the learned flow for all running stations, and performs diagnostics or shutdowns when alarms occur. **Flow Monitor requires one or more flow sensor inputs** in order to operate, and at least one Master Valve (P/MV) per flow sensor to be effective.

At the Flow menu, check the boxes to **Enable Flow Manager** and/or **Enable Flow Monitor** if desired. Verify that all set up information is exactly correct according to the following steps.

MAINSAFE™

Enable MainSafe has its own check box. MainSafe is a special function for higher level flow monitoring and mainline protection.



Do not check the MainSafe box until the optional feature is completely understood.

MainSafe requires a separate flow meter and master valve. It is designed to protect longer runs of large diameter mainline pipe that are upstream from the Flow Zones themselves. If a mainline pipe experiences a high flow, or continues to flow when all irrigation is suspended, MainSafe provides a rapid shutdown response to prevent a prolonged serious leak.

MainSafe can also be configured to watch over separate, always-on manual watering pipes, and provide an emergency response if a break occurs.

SET UP FLOW MONITOR

The Flow Monitor requires the following information to operate correctly:

- Install and set up a flow sensor (Devices menu).
- Install and set up a P/MV (Devices menu).
- Set up a Flow Zone, and complete all information for the Flow Zone (Flow menu).
- Attach each station to a Flow Zone (Station Setup menu).
- Learn flow for all stations with run times (Flow menu).

FLOW ZONES

A Flow Zone defines a section of pipe and a group of stations attached to that pipe, which is managed as a hydraulic unit. Flow Zones are used for both Flow Manager and Flow Monitor.

Each Flow Zone has a check box for “Manage Flow” and “Monitor Flow”. To monitor flow, check that box. Then complete the settings and rules for the Flow Zone.

Overflow/Underflow Alarm Limits: ACC2 sets the over and underflow limits for each station’s learned flow at the flow zone level. Enter the maximum and minimum flow percentages you want the Flow Zone to allow for the stations attached to the Flow Zone. If these limits are set too close to 100%, there is a greater chance of false alarms, due to natural fluctuations in the flow.

FLOW MAP

In the Flow Zones menu, press the soft key for Flow Map. This tells the controller how the Flow Zone is connected, and which devices are used in that hydraulic unit. All stations must be downstream from the flow sensors and master valves that are checked here.

Flow Sensor Assignment: Check the box for the Flow Sensor or sensors connected to the Flow Zone.

If an X is in one of the Flow Sensor boxes, the sensor has already been assigned to another Flow Zone, and is not available for this Flow Zone.

If a Flow Sensor number does not appear, it has already been assigned to a MainSafe, and is not available for Flow Zone monitoring.

P/MV Assignment: Check the box for the Master Valve that is installed in line with the flow sensor on this flow zone.

If an X is in one of the P/MV boxes, it has already been assigned to another Flow Zone, and is not available for this Flow Zone.

If a P/MV number does not appear, it has already been assigned to a MainSafe, and is not available for Flow Zone monitoring.

MainSafe™ Assignment: If using this optional feature, select the MainSafe zone that is upstream from the Flow Zone. If MainSafe is not being used, leave this set to “None.”

The selected MainSafe flow sensor and P/MV assignments are shown at the bottom of this screen.

FLOW LIMITS

In the Flow Zones menu, press the soft key for Flow Limits.

The screenshot shows the 'Flow Zones' menu for 'Flow Zone 1'. The 'Name' field is 'Flow Zone 1'. Under 'Flow Zone Flow Limits', 'Maximum Flow' is set to '75 GPM' and 'Unscheduled Flow' is set to '9.0 GPM'. Under 'Flow Alarm Delays', 'Alarm Delay' is set to '2:00 (M:SS)' and 'Alarm Clear Delay' is set to '23:59 (HH:MM)'. On the right side, there are icons for 'Next Flow Zone', 'Flow Map', 'Allowances', and 'Setup'.

Maximum Flow: Sets the highest possible flow rate allowed in the Flow Zone for any reason. This should be considerably larger than the maximum flow allowed in normal irrigation (so that it does not alarm before station-level diagnostics can be performed). When the flow sensor detects a flow higher than this, the irrigation will be shut down.

Unscheduled Flow: This is the maximum amount of flow allowed when no stations are actively running. This is only to allow manual watering by hand when the controller is not watering automatically. When the rate is exceeded, the controller will alarm.

If Unscheduled Flow is set to OFF, the controller will not respond to unscheduled flow.

Flow Alarm Delays: Sets an amount of time before the Max or Unscheduled flow rates will cause an alarm, and sets how long the Flow Zone will be shut down.

Alarm Delay: High flows will alarm immediately if this is set to None. Enter a time to allow high flow before it is treated as an alarm. This can prevent false alarms when flow is unstable. Set in M:SS format; the longest delay is 9 minutes, 59 seconds. This can eliminate false alarms from temporary surges in flow.

This delay should be longer than the delays for the stations attached to the Flow Zone.

Alarm Clear Delay: Sets the amount of time a Flow Zone will remain shut down before allowing new automatic irrigation attempts. Set in HH:MM format, the longest delay setting is 23 hours, 59 minutes.

If Alarm Clear Delay is set to **Manual Only**, automatic irrigation will never resume after a high flow or unscheduled flow alarm, until it is manually cleared by an operator at the controller. The operator must dial to the Flow menu, select **Clear Flow Alarms**, the Flow Alarms that should be cleared, and click Clear Selected.

FLOW ALLOWANCES

In the Flow Zones menu, press the soft key for **Allowances**.

The screenshot shows the 'Flow Zones' menu for 'Flow Zone 1'. The 'Name' field is 'Flow Zone 1'. Under 'Watering Budget', 'Monthly Budget' is set to '220000 GAL'. Under 'Manual Watering Allowance', 'Additional Flow' is set to '9.0 GPM'. On the right side, there are icons for 'Next Flow Zone', 'Flow Map', 'Setup', and 'Flow Limits'.

Watering Budget: Enter the total amount of flow that can be allowed in this Flow Zone in the calendar month. If the total flow exceeds the monthly budget, an alarm message will appear on the screen. The controller will not automatically stop watering when this alarm occurs.

Manual Watering Allowance: Sets an additional flow rate amount allowed for manual irrigation. This amount is added to the high flow limit to allow for any manual watering that might occur during automatic irrigation.

STATION SETUP

Dial to the Stations menu, and choose Station Setup. Each station must be assigned to a Flow Zone to complete Flow Monitor operation.

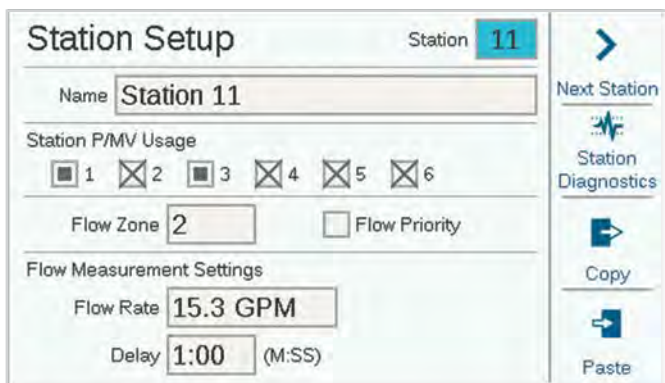

The screenshot shows the 'Station Setup' interface for 'Station 11'. The 'Name' field is 'Station 11'. Under 'Station P/MV Usage', checkboxes 1, 3, and 6 are selected, while 2, 4, and 5 are unselected. The 'Flow Zone' is set to '2' and 'Flow Priority' is unchecked. Under 'Flow Measurement Settings', the 'Flow Rate' is '15.3 GPM' and the 'Delay' is '1:00 (M:SS)'. On the right side, there are four soft keys: 'Next Station' (with a right arrow), 'Station Diagnostics' (with a pulse icon), 'Copy' (with a right arrow), and 'Paste' (with a left arrow).

STATION P/MV USAGE

Station P/MV usage may have already been assigned during basic operations set up. If not, the desired P/MV activations may be made here for each station. If some selections are gray and not selectable, the P/MV output has already been assigned to a different function.

FLOW ZONE

This is the critical setting to tell the controller which Flow Zone the station belongs to. In effect, this also tells it which flow sensor will be reading the flow for the station. Flow Monitoring cannot work until all necessary stations have been assigned to a Flow Zone.

FLOW PRIORITY

The priority setting is used for Flow Manager, but is not used for Flow Monitor. It helps the controller decide which stations to run sooner to achieve Flow Targets, in case there is not enough time to complete all irrigation.

FLOW MEASUREMENT SETTINGS

This is how the controller knows what the station should flow under normal conditions. It can either be entered manually, or learned automatically by the controller with a flow sensor.

For Flow Monitor, this should be left blank until the Flow Learning function fills it in automatically.

For Flow Manager, learned flow is the most accurate, but it is also possible to enter the flow rate by hand if the controller is not equipped with flow sensing.

COPY AND PASTE

The copy and paste soft keys can be used to duplicate the upper half of the Station Setup screen for many similar stations on the same Flow Zone. They will copy the P/MV Usage and Flow Zone setting to subsequent stations.

Set up the first station, press the copy button, and then click the Next Station soft key, and Paste. It is easiest to work down one Flow Zone at a time, if multiple Flow Zones are created.

LEARN FLOW

The final step in Flow Monitor setup (unless the MainSafe™ option is enabled) is the actual learning process.

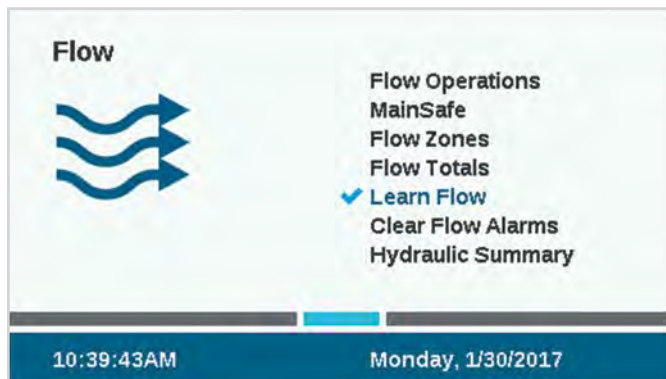

Dial to the **Flow** menu, and select **Learn Flow**. The screen will show the status of the last learn flow attempt, if there was one.

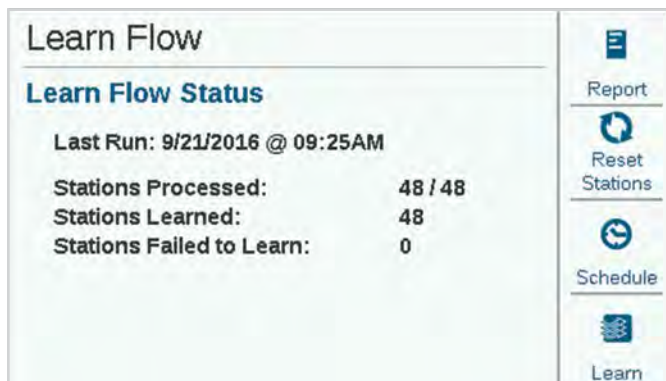

Flow learning will only test stations that already have a Run Time in a program.

Flow learning will cancel all other irrigation, automatic and manual, until the learning is complete. Flow cannot be learned while other stations are running for other reasons.

Press the soft key for **Report** to verify that stations are ready to learn. This will show how many flow sensors are configured, how many stations have run times, and how many already have flow rate data.

If all stations have run times, press the **Learn** soft key. The controller will begin starting stations, one at a time, for up to 5 minutes each, plus the delay time set for the station) to learn the flow. If flow stabilizes sooner, the controller will move to the next station without running the full 5 minutes.

Flow learning can be a lengthy process, depending on how many stations there are, and how stable the flow is.

When the learning is complete, the **Learn Flow** screen will summarize how many stations were learned, and how many have failed. Troubleshoot the failed stations (either in setup, or in the field) and try learning again to fill in the failed stations.

SCHEDULE FLOW LEARNING

It is possible to set the controller to Learn Flow automatically at a later time and date. Remember that **flow learning will cancel any other automatic irrigation**, so choose a time and date that are not conflicting with critical irrigation.

HYDRAULIC SUMMARY

Dial to the Flow menu, and select Hydraulic Summary. The Hydraulic Summary is a report of exactly how the controller hydraulics are set up at the moment. It shows the connections of all flow-related objects, from MainSafe zones (if applicable), Flow Zones, Flow Sensors, P/MVs, to individual stations.

Use the soft keys to view by Controller, by Flow Zone, and by MainSafe (if applicable).

This is the easiest way to review the current setup, and see if anything is incorrect or incomplete.

FLOW TOTALS

Flow Totals are total amounts of water consumed over a specified time period. They may also be viewed at different levels, depending on how the controller is configured.

Total Flow is counted by MainSafe (if applicable), by Flow Zone, and by individual flow sensor.

Flow totals can be viewed at any of these levels by clicking soft keys for Day, Week, Month, or Year. Click the Interval field to select a desired date range.

Click in the Interval field to specify the time period to view.

Controller	5652 GAL
MainSafe 1 (Sensor 1)	1946 GAL
Flow Zone 1	424 GAL
Flow Sensor 2	424 GAL
Flow Zone 2	560 GAL
Flow Sensor 3	560 GAL

VIEW FLOW

Current flow rate on all sensors can be viewed from the Home/Activity screen at any time. Press the soft key for View Flow to see actual flow on up to 6 flow sensors.

If the controller is equipped with the optional Wi-Fi module, the current flow can also be viewed on a mobile device.



 If the View Messages soft key is active, you must clear the messages before the View Flow key appears.

FLOW ALARM HANDLING

When stations are running, the Flow Monitor continuously checks the actual flow from the sensor(s) against the combined learned flow of the stations, including the overflow and underflow percentages allowed in the Flow Zone. It also checks this flow against the higher level Flow Zone limits, and MainSafe™ limits if applicable.

If the total amount caused by running stations is exceeded beyond the permissible station delay periods, the controller pauses all stations (shutting off the P/MV) in the Flow Zone. It waits 60 seconds after the stations are paused, for the flow to drop to near 0.



STATION LEVEL ALARMS

If flow does drop to near zero when the Flow Zone is paused, the controller then begins running the stations that were running at the time of the alarm, one by one, to test which station(s) are causing the high flow conditions. The controller will mark failed stations in the logs, and continue irrigating with stations that pass the individual flow tests.

FLOW ZONE OR MAINSAFE™ ALARMS

If flow does not drop substantially during the diagnostic pause period, the controller determines there is a Mainline Overflow, and will not resume irrigating or perform further diagnostics. It will remain shut down for the period specified in the Alarm Clear Delay setting on the Flow Zones screen.

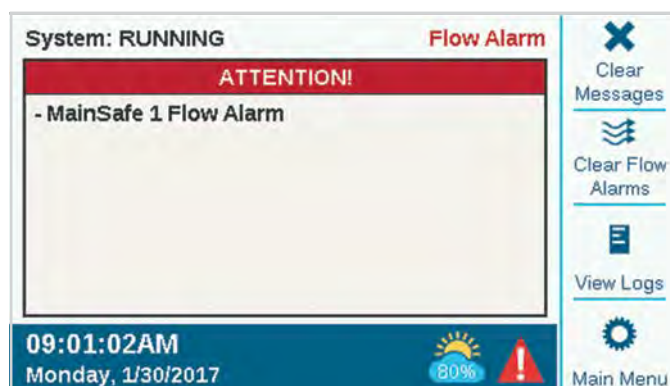

When flow alarms are detected at the Flow Zone or MainSafe level, they can be cleared from the Flow menu, Clear Flow Alarms. A shortcut key is also available to Clear Flow Alarms when these conditions are detected, after View Messages has been selected.

If the actual flow exceeds the Maximum Flow allowance for the Flow Zone, and continues for the time set in the Alarm Delay, the Flow Zone alarms and shuts down without further diagnostics. The same applies to MainSafe zones, if applicable. The controller assumes the overflow condition is the result of a mainline failure, above the station level.

If flow exceeds any Unscheduled Flow allowance when no stations are supposed to be running, and continues for the time set in the Alarm Delay, the Flow Zone and/or MainSafe zone will also be shut down.

SET UP FLOW MANAGER

Flow Manager runs simultaneous stations to reach a programmable flow rate target. It allows the controller to decide which stations to run, to keep total flow as close to the pipe design capacity as possible, and shorten the overall watering time.

Flow Manager does not require a flow sensor, but it must have station flow values to work with. If flow learning via a sensor is not available, approximate values may be entered manually.

Flow Manager does require one or more Flow Zones, and requires stations to be attached to the Flow Zones in order to function. Flow Manager and Flow Monitor can also work at the same time, and use much of the same information in different ways.

Flow Manager requires the following information to operate correctly:

- Set up Flow Zones and set Flow Targets (Flow menu, Flow Zones)
- Attach stations to Flow Zones (Stations, Station Setup)
- Learn or enter station flow rates (Stations, Station Setup)
- Set Controller Program Limits, (Stations, Station Limits menu), if desired.

FLOW ZONES

Dial to the Flow menu and select Flow Zones if they have not already been created. The Flow Zone defines a section of pipe and a group of stations attached to that pipe, which is managed as a hydraulic unit.

For Flow Manager, it is only necessary to Enable Flow Management and set the Flow Target. Check the box for **Manage Flow**.

FLOW TARGET

The **Flow Target** box is used to set the flow rate desired for the Flow Zone throughout irrigation. Enter the desired rate of flow that is best for the mainline pipe diameter (recommended at 5 feet per second or 1.5 meters per second) or a preference based on other factors.

The screenshot shows the 'Flow Zones' configuration interface. At the top, it says 'Flow Zone 1'. Below that, there's a text input field for 'Name' with 'Flow Zone 1' entered. There are two main sections: 'Manage Flow' and 'Monitor Flow'. The 'Manage Flow' section has a checked checkbox and a 'Flow Target' field set to '50 GPM'. The 'Monitor Flow' section has an unchecked checkbox and two fields: 'Overflow Alarm Limit' set to '115%' and 'Underflow Alarm Limit' set to '50%'. On the right side, there are four icons with labels: 'Next Flow Zone', 'Flow Map', 'Allowances', and 'Flow Limits'.

This is the only setting necessary at the Flow Zone menu for the Flow Manager function. Flow Manager will try to run enough simultaneous stations to stay at or near this rate of flow whenever there are programs available to run.

STATION SETUP

Flow Manager requires:

- The station's Flow Zone assignment
- The Flow Priority (checked or not checked)
- The station Flow Rate.

The screenshot shows the 'Station Setup' interface for Station 1. The 'Name' field is 'Station 1'. Under 'Station P/MV Usage', checkboxes for 1, 2, 3, 4, 5, and 6 are shown, with 1 and 2 checked. The 'Flow Zone' is set to 1, and the 'Flow Priority' checkbox is checked. Under 'Flow Measurement Settings', the 'Flow Rate' is 11.1 GPM and the 'Delay' is 1:00 (M:SS). On the right side, there are buttons for 'Next Station', 'Station Diagnostics', 'Copy', and 'Paste'.

FLOW ZONE

This tells the controller which Flow Zone the station belongs to.

A different flow target can be set for each flow zone. The flow target should be a safe rate of flow (approximately 5 ft/sec or 1.5 m/sec) for the diameter of the mainline pipe in the flow zone.

It is also possible to have Flow Zones that run without Flow Manager, simultaneously with Flow Zones that are being managed.

FLOW PRIORITY

The priority setting helps the controller decide which stations to run sooner to achieve Flow Targets. Stations with the Priority box checked will be considered first, so that less critical stations can occur later in the irrigation.

FLOW RATE

If the system is equipped with a flow sensor, it is best to use the "Learn Flow" function to let the controller fill these values in.

If the system does not have a flow sensor, look up or calculate reasonable flow values for each station, and enter manually for each station.

Note that Copy and Paste do not work with flow rates. They only copy the upper half of the screen, including P/MV and Flow Zone assignments.

STATION LIMITS

Dial to Stations, Station Limits to review or change the number of stations that are allowed to run at once.

It is not necessary to change Station Limits for Flow Manager to operate, but it is possible. These settings can be used to customize the results of flow management.

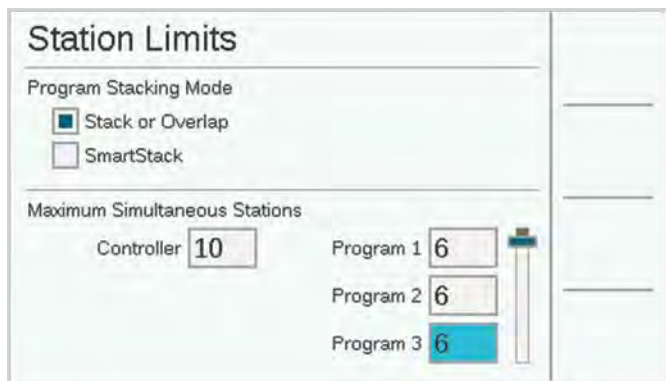

Maximum Simultaneous Stations sets a hard limit on the number of stations the controller can run at once, regardless of Flow Manager or other settings. The ACC2 conventionally-wired controller can run approximately 14 Hunter solenoids at once, including P/MV outputs. The maximum number of solenoids may vary to other factors.

Enter a Controller number that meets your needs if the default of 10 is not desirable.

If Flow Manager is enabled, a **maximum number of simultaneous stations per program** can also be entered. This can be useful to force the controller to spread irrigation across multiple programs.

Example: Program 1 runs turf zones, and Program 2 runs Shrub zones. If they are both part of the same flow managed Flow Zone, and you know the Flow Zone can run about 6 zones at once, you could set a limit of “3” on Program 1 and “3” on Program 2. The controller will still flow manage to your target flow, but could only run 3 in either program to get there.

If the Flow Target rates are well below the rates that the Controller and Program station limits would allow, the station limits will never be reached. The controller will decide which stations to run, and in what order.

MAINSAFE™

A MainSafe is an optional level of flow monitoring and protection above the Flow Zone level. It is especially useful when:

- More than one Flow Zone has been configured from the same water supply.
- When there is a long distance between the point of connection and the beginning of the actual Flow Zone(s).
- When separate mainlines are in a constantly charged state for the sole purpose of manual watering.



MainSafe zones generally require their own flow sensor, and their own Master Valve. Often these are Normally Open Master Valves, which only close in the event of an alarm.

To set up a MainSafe, dial to the Flow menu, and select MainSafe.

SETUP SCREEN

Press the soft key for Setup.

This allows the MainSafe to be named (recommended).

Check the box to enable Monitor Flow.

Assign the P/MV output and Flow Sensor that are assigned to the MainSafe.

The Flow Zones check marks and X's cannot be set here. They show the relationship of this MainSafe to the Flow Zones.

These are assigned in the Flow Zones menu, Flow Map screen.

FLOW LIMITS SCREEN

Press the soft key for Flow Limits.

MainSafe		MainSafe	2
Name	MainSafe 2		
MainSafe Flow Limits			
Maximum Flow	250 GPM		
Unscheduled Flow	Off		
Flow Alarm Delays			
Alarm Delay	3:00	(M:SS)	
Alarm Clear Delay	23:59	(HH:MM)	

MAXIMUM FLOW

Maximum Flow is an absolute high limit for all flow from the MainSafe level (the water source). If the flow rate exceeds that amount, irrigation will be shut down. It does not matter what stations are running or what the learned flow is.

This should be considerably larger than the maximum flow allowed in normal irrigation in all downstream Flow Zones (so that it does not alarm before station-level and Flow Zone diagnostics can be performed).

UNSCHEDULED FLOW

Unscheduled Flow is any flow that is detected by the flow sensor when no stations are running. A flow rate can be entered here to permit manual watering up to the specified amount, without causing an alarm or shutting off the water. If unscheduled flow is detected over that amount, an alarm will occur.

ALARM DELAY

High flows will alarm immediately if this is set to None, or they will be ignored until they have lasted as long as the time entered here. Set in M:SS format; the longest delay is 9 minutes, 59 seconds. This can eliminate false alarms from temporary surges in flow.

ALARM CLEAR DELAY

Sets the amount of time a MainSafe zone will remain shut down before allowing new automatic irrigation attempts. Set in HH:MM format, the longest delay setting is 23 hours, 59 minutes.

If Alarm Clear Delay is set to **Manual Only**, automatic irrigation will never resume after a high flow or unscheduled flow alarm, until it is manually cleared by an operator at the controller. The operator must dial to the Flow menu, select **Clear Flow Alarms**, the Flow Alarms that should be cleared, and click Clear Selected.

ALARM CLEAR DELAY

Specifies how long the MainSafe zone will remain shut down after a Max Flow or Unscheduled Flow alarm occurs, in hours:minutes. This is set to 23 hours, 59 minutes, but this can be changed to other intervals, or set to Manual Only.



If Alarm Clear Delay is set to **Manual Only**, the controller will not water again until a user visits the site, and manually clears the flow alarm. This assumes a mainline break has occurred and that no watering should occur until it is repaired.

ALLOWANCES SCREEN

Press the Allowances soft key to set the monthly budget and manual watering allowances.

MONTHLY BUDGET

Enter the total amount on the Allowances screen in this MainSafe™ in the calendar month. If the total flow exceeds the monthly budget, an alarm message will appear on the screen. The controller will not automatically stop watering when this alarm occurs.

MANUAL WATERING ALLOWANCE

This is an additional amount of flow that is permitted over all other flow rate limits for manual watering that may occur during automatic irrigation. An alarm will not occur until other limits, plus the amount entered here, have been exceeded.

Conditional Response

Conditional Responses allow a sensor or condition to trigger something to happen. This can be as simple as telling a station to start when a sensor is opened, to much more complex operations such as switching water supplies to a Flow Zone based on a sensor position.

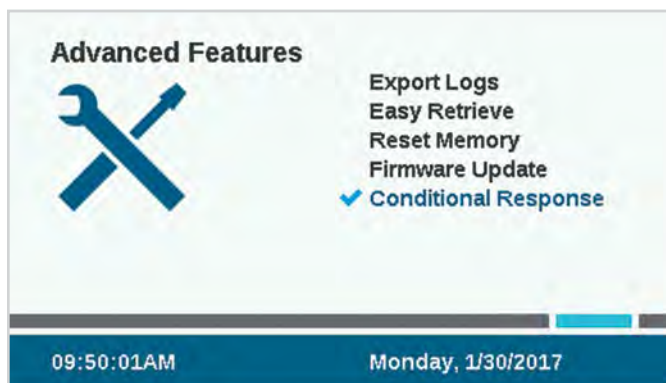

Conditional Responses are written in the form of a statement, which reads “if THIS happens, then do THAT.”

The controller may have up to 35 Conditional Response statements. Some responses may require more than one statement to achieve certain results (such as switching P/MVs).

SOS (STATUS OUTPUT STATION)

An SOS is a dedicated station output that is only used with Conditional Response. The purpose of the SOS is to trigger an external light or other device when the controller is in an alarmed state, so that field personnel can be notified of an alarm without having to open the controller door.

An SOS requires a dedicated station number to operate (any station number may be used). The station will turn on whenever the Conditional Response condition is in effect.

The station output may be used to directly power a 24VAC signal lamp installed in a conduit hole, or used to activate a relay for other purposes.

SETUP AN SOS STATION

In the Conditional Response screen, use the “Then” soft key to select a “Start SOS Output” Type.

At Selection, select the unused station you want to designate as the SOS station.

- This station must not be included in any irrigation programs.
- Only one SOS station should be used per controller.
- All other SOS responses should be selected to the same SOS station number.

The SOS station output will be wired directly to the external light or other 24V powered device.

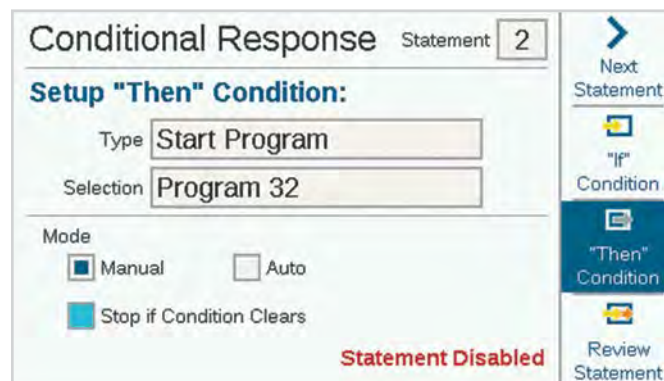

SET UP A CONDITIONAL RESPONSE

Dial to Advanced Settings and select Conditional Response. Each response has a soft key for the “If” condition, a “Then” condition or action, and “Review Statement” to verify that the complete response will meet the goal.

 You must review the statement and then enable it with the Enable checkbox, for the response to be in effect.

The possible responses depend on the object (Type) chosen in the “If” statement.

- An “If” statement is for a certain type of condition to function as a trigger.
- A “Then” statement is for the action taken as a response to the trigger.



Conditional Response Statement **1**

Setup "If" Condition:

Type: Clik Sensor

Selection: Clik Sensor 1

Condition: Alarm

Statement Disabled

Next Statement

"If" Condition

"Then" Condition

Review Statement

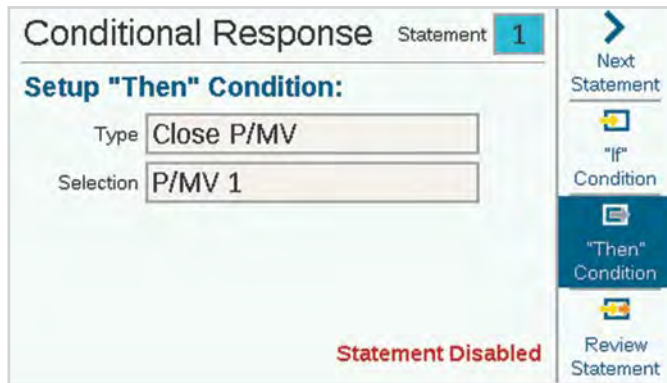

Conditional Response Statement **1**

Setup "Then" Condition:

Type: Close P/MV

Selection: P/MV 1

Statement Disabled

Next Statement

"If" Condition

"Then" Condition

Review Statement

Clik Sensors can use alarms as a trigger. They can also trigger based strictly on their position, Closed or Open, without causing an alarm.

Examples: A Clik could start a program, station, etc. whenever it alarms; or a Clik input could switch between two different Master Valves, based on whether it was open or closed.

Flow Zones and MainSafe zones can use Max Flow rate or Unscheduled Flow as triggers. Flow Zone triggers can be used to start an external alarm indicator, or to close a P/MV.

“Any Alarm”, or just a list of “Critical Alarms”, can be used as triggers, usually to start an external alarm indicator (see SOS).

 You must Review and Enable the statement (checkbox) before the Conditional Response statement is active.



Conditional Response Statement **1**

Enable Statement

Completed Statement:

If Clik Sensor 1 Alarm Active,
Then Close P/MV 1

Next Statement

"If" Condition

"Then" Condition

Review Statement

SET UP A CONDITIONAL RESPONSE

Dial to Advanced Settings and select Conditional Response.

"IF" Type	Selection	Condition (Trigger)	"THEN" Actions	Other Rules
Click Sensors	Clik 1 Clik 2 Clik 3	Alarm Open Close	Start Station Start Block Start Program	Manual/Auto Stop if Clears Yes/No
Solar Sync	Solar Sync Rain Solar Sync Freeze	Alarm	Close P/MV Start SOS	
Flow Zone	Flow Zone 1-6	Max Flow Unscheduled Flow Mainline Overflow	Start SOS	
Water Source	Water Source 1-6	Max Flow Unscheduled Flow	Start SOS	
Any Alarm	(All Alarms)		Close P/MV	
Critical Alarm	(Serious Alarms)	Alarm	Start SOS	

START STATIONS, PROGRAMS, AND BLOCKS

When using Conditional Response to start a station, Block, or program, other options appear below the selection.

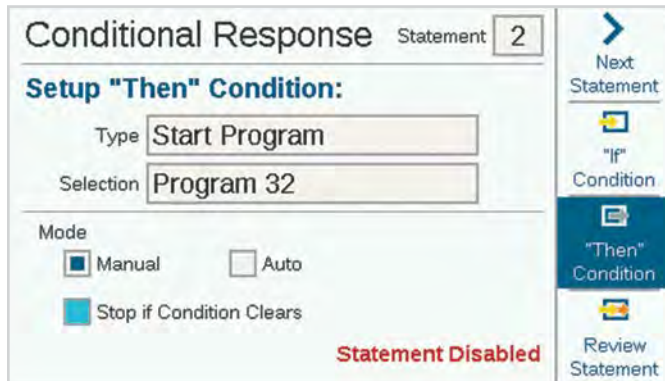

MODE

If the Mode is set to **Manual**, the station, Block, or program will run alone, and all other automatic irrigation is stopped until the response is finished.

If the Mode is set to **Auto**, the response will occur without halting other scheduled irrigation. If the system is using Flow Manager, the response may not begin immediately. The responding stations will be fit into the Flow Target, as available, by the Flow Manager.

If **Stop if Condition Clears** is checked, the station, Block, or program will only run while the trigger condition is present. If the condition continues, a station or Block will run for the specified run time, and a program will run once for the duration of the program.

If the box is not checked, the response will continue for the total run time or duration of the program.

SWITCH P/MVS

To enable P/MV switching on sensor input, each station in the affected Flow Zone should be set to call for both P/MV outputs.

When the sensor is alarmed, or changes position, it should then be set to “Close P/MV” for the P/MV that is not wanted. In this way, only 1 P/MV would be active at any given moment, because the stations are calling for both of them, but one is disabled by the sensor input.

Example: There are two points of connection available, one potable water, and one non-potable. Each has its own Master Valve. A float switch is installed to monitor the non-potable level. All stations are set at Station Setup to call for both Master Valves.

When the float switch is closed, it disables the P/MV for the potable water supply, so only non-potable water is used.

When the float switch is open, it disables the P/MV for the non-potable supply, so only potable water is used.

They will not both be disabled at the same time, since only one position can be in effect at a time.

Troubleshooting

Symptom	Solution
Attention messages	Press View Messages, and/or View Logs Continue troubleshooting based on log reports
Non Water Window violation	Review program start time and Non Water Window setup
Won't run programs/stations	Review Program or Station Summary
No display	Make sure facepack cable is connected Make sure both slide locks are closed Make sure power is on to controller Check Power Supply Board status light
Overflow messages	Verify flow limits and delays allow for some variation Check system for leaks and malfunctions
Won't read flow	Check flow sensor wiring Check flow sensor setup
Electrical or module malfunctions	Go to Diagnostics menu, review all components







Helping our customers succeed is what drives us. While our passion for innovation and engineering is built into everything we do, it is our commitment to exceptional support that we hope will keep you in the Hunter family of customers for years to come.

A handwritten signature in black ink, appearing to read 'G. R. Hunter', is positioned above the name. The signature is fluid and cursive, with a long horizontal stroke extending to the right.

Gregory R. Hunter, President of Hunter Industries

RESIDENTIAL & COMMERCIAL IRRIGATION | *Built on Innovation®*

1940 Diamond Street, San Marcos, California 92078 USA

Learn more. Visit hunterindustries.com